

DRIESCHER - Air-Insulated Medium-Voltage Compact Switchgears for Substations

- Rated voltage
12 kV to 24 kV
- Bemessungsstrom
400 A and 630 A



24 kV

ELEKTROTECHNISCHE WERKE
FRITZ DRIESCHER & SÖHNE GMBH

D-85366 MOOSBURG • TEL. +49 87 61 6 81-0 • FAX +49 87 61 68 11 37
<http://www.driescher.com> email: Driescher@aol.com



DRIESCHER - Compact Switchgears for Substations

in compliance with DIN VDE 0670, Part 6 (IEC 60298)

• 3

General

• 4

Operating conditions, Technical standards, Technical Data

• 5

Description of the compact switchgears

• 6

Compact switchgears 12 kV

• 8

Compact switchgears 24 kV

• 11

Withdrawable plates, Auxiliary equipment, Weights

• 12

Production program

Elektrizitäts
wirtschaft

ewm

das magazin für die energie wirtschaft

DRIESCHER Moosburg



Unsere langjährige Erfahrung und unsere Erfolge auf dem Gebiet der Elektrotechnik läßt uns Konzepte und Ideen entwickeln, die unseren Kunden problemübergreifende Lösungen bieten.

Driescher Luftisolierte Kompakt-Lastschaltanlagen sind als Komplettlösung äußerst platzsparend und attraktiv im Preis, ohne auf relevante Funktionen konventioneller Anlagen verzichten zu müssen. Passend sind unsere Kompaktanlagen für Betonstationen aller namhafter Hersteller.

Der Erfolg eines Unternehmens bemißt sich an der Qualität seiner Produkte, die den Kunden einen spürbaren Mehrwert bieten.

Luftisolierte Kompakt-Lastschaltanlagen von 12 kV bis 24 kV



- Reduced to the Maximum
- passend für Betonstationen aller namhafter Hersteller
- kompakte Abmessungen

POWER



Mehr Energie ...

Besuchen Sie uns auf der
ELTEC 2001 • Halle 6 • Stand 163

Elektrotechnische Werke Fritz Driescher & Söhne GmbH • Driescherstr. 3 • 85368 Moosburg
Tel. (0 87 61) 68 10 • Fax (0 87 61) 68 11 37 • www.driescher.de • infoservice@driescher.de

General

The new air-insulated DRIESCHER medium-voltage compact switchgears are ideal for application in secondary substations without control aisles.

They meet the user's specific requirements to the full and ensure a satisfactory power distribution.

These new air-insulated medium-voltage compact switchgears have been designed to meet demands for flexibility, maximum levels in quality and safety as well as maximum operating convenience in the network control.

- Compact dimensions
- No need for gaseous or solid insulators
- Environmental compatibility, also in the event of a malfunction; there are no toxic reaction products under the influence of accidental arcs
- Future-oriented design with subassemblies which are predominantly recyclable, hazardous substances are avoided.
- No special surge voltage protector equipment and cable sealing ends
- Maximum safety
- Easy handling
- Minimum amount of maintenance

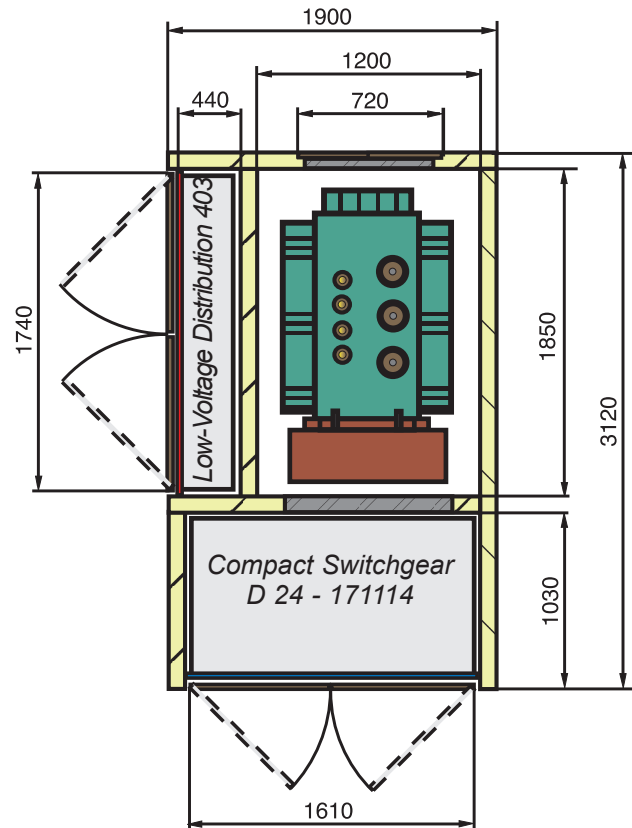

Height (above floor) 1600 mm

Drawing:

Example of secondary unit substation with

- Medium-voltage compact switchgear, Type D 24 - 171114 comprising two cable panels as well as a transformer feeder
- Low-voltage distribution, Type 403 with infeed of max. 1250 A and up to ten outgoing circuits 400 A / 630 A
- Maximum transformer rated power 2500 kVA

Upon request we can also provide complete secondary substations!

Operating Conditions

The air-insulated compact switchgears are installed in closed electrical operating areas to which only trained personnel and appropriately instructed persons have access.

The equipment can be used at altitudes of up to 1000 m above sea level.

For installations above an altitude of 1000 m the rated insulating level of the switchgear must be corrected accordingly. The switch panels are designed for use under normal operating conditions in compliance with the standard DIN VDE 0670, Part 6 (IEC 60694).

Technical Standards

The design of the air-insulated switchgears corresponds to the specifications of the DIN VDE 0670, Part 6 (IEC 60298). The resistance to accidental arcs of the switch panels has been determined at 16, 20 and 25 kA; 1 s, by an independent testing institute.

The installed switchgear equipment is designed in compliance with DIN VDE 0670, Part 1000 (IEC 60694). The degree of protection of the switch panels corresponds to IP 3X. The technical data of the installed switch-disconnectors are given in list 727.

Technical Data

Rated voltage	U_r 12 kV	Rated short-circuit duration	t_k 1 s
Rated lightning impulse withstand voltage	U_p 75 kV	Rated frequency	f_r 50 Hz
Rated short-time withstand voltage	U_d 28 kV		

Rated voltage	U_r 24 kV	Rated short-circuit duration	t_k 1 s
Rated lightning impulse withstand voltage	U_p 125 kV	Rated frequency	f_r 50 Hz
Rated short-time withstand voltage	U_d 50 kV		

Technical data for the installed switchgear equipment	Rated (operating) current I_r	Rated short-time current I_k	Rated peak current I_p
Switch-disconnector H 27	400 A and 630 A	up to 20 kA	up to 50 kA

Description of the Compact Switchgear

Design

The air-insulated medium-voltage compact switchgears comprise at least one outgoing feeder cable and one transformer feeder.

The compact switchgears frame is made of a screwed, hot-galvanized composite structure.

The entire compact switchgear is metal-encapsulated to guarantee optimal protection to persons and plant.

The compact switchgears are fitted at the front with single-wing sheet steel doors which have inserted compound glass windows for visual inspection of the switch-disconnectors.

Every compact switchgear has a screwed on rear panel of galvanized sheet steel with separate assembly openings.

Connecting cables are conducted from the bottom into the switch panels where they are mounted on adjustable rails.



Fig.:
24 kV Compact switchgear
Type D 24 - 121114 open

Equipment

The cable panels are equipped with an in-line switch-disconnector H 27 EK.

A fuse switch-disconnector H 27 SEA or H 27 SuT is installed in the transformer feeder panel. The HV-HBC fuse mounting contacts have been turned through 90° to optimally use the available space (fuses can be pulled out towards the front).

The compact switchgears can, of course, also be equipped with an earthing switch as well as with current and voltage transformers.

The optimal interlocking of the devices practically rules out any incorrect operation.

Earthing switches or spherical fixed points are available for earthing and short-circuiting.



When work is being carried out protective plates can be inserted in the open isolating distance of the switching devices in question, with the door closed.

Pressure relief is in downward direction.

The doors and covers of the switchgear are painted in structural paint (selectable in different colours to meet the customer's request).







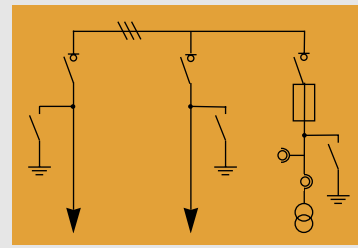
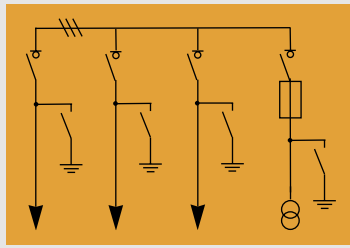

All switch panels are designed for central locking with double-bit key. Additional locking means, with profile cylinder or padlock, are available on request.

DRIESCHER - Compact Switchgears 12 kV

 optional
 not possible



Type D 12 - 147014

Switch-disconnector	H 27 EK	H 27 SEA	H 27 EK	H 27 SEA
Earthing switch				
Current transformer	-	-		
Voltage transformer	-	-		

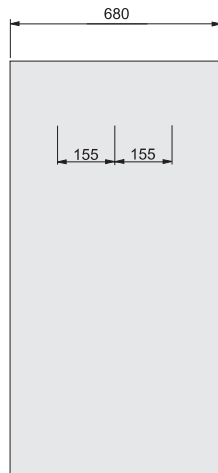
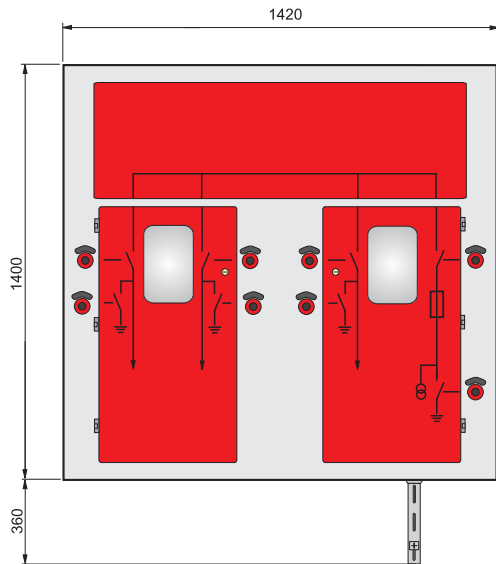

- Rated voltage
12 kV
- Rated (operating) current
630 A
- Rated isolation level
75 kV

Fig. 1:
12 kV Compact switchgear in front and side view

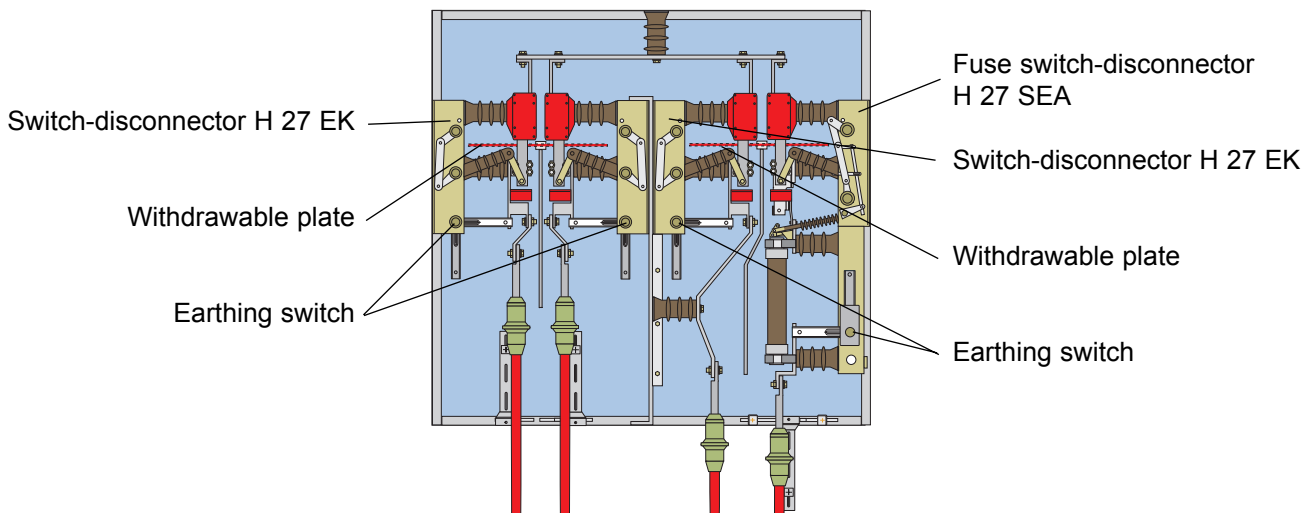

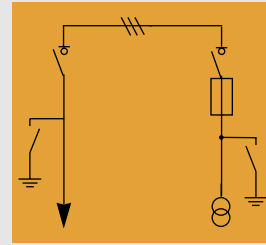
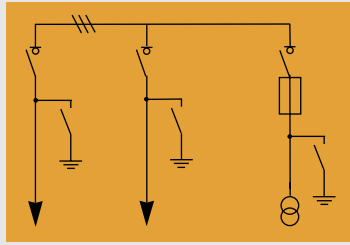



Fig. 2:
12 kV Compact switchgear - open

DRIESCHER - Compact Switchgears 12 kV

 optional
 not possible



Type D 12 - 127014

Switch-disconnector	H 27 EK	H 27 SEA	H 27 EK	H 27 SEA
Earthing switch				
Current transformer	-		-	
Voltage transformer	-		-	

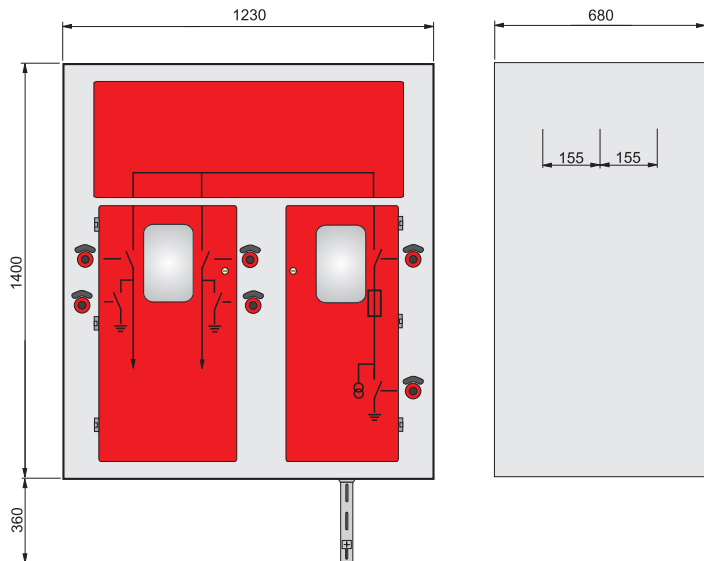

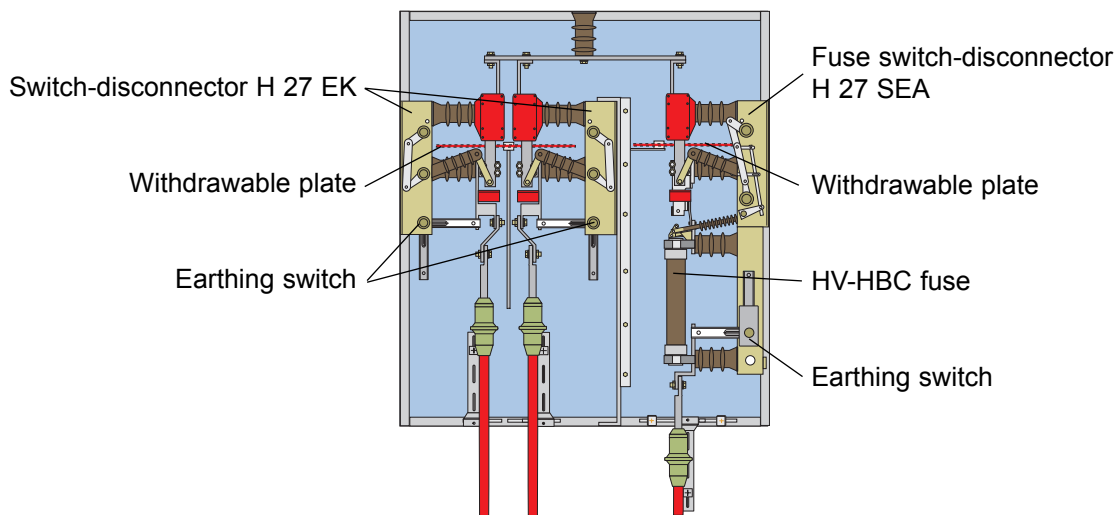

- Rated voltage
12 kV
- Rated (operating) current
630 A
- Rated isolation level
75 kV

*Fig. 3:
12 kV Compact switchgear in front and side view*









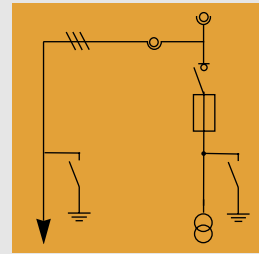
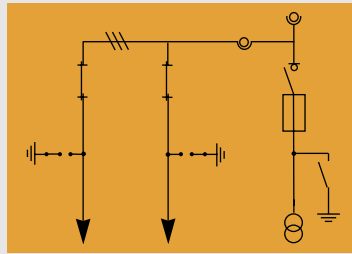





*Fig. 4:
12 kV Compact switchgear - open*

DRIESCHER - Compact Switchgears 24 kV

-  optional
-  not possible



Type D 24 - 121114

Switch-disconnector	H 27 EK	H 27 SuT	H 27 EK	H 27 SuT
Earthing switch				
Current transformer				
Voltage transformer				

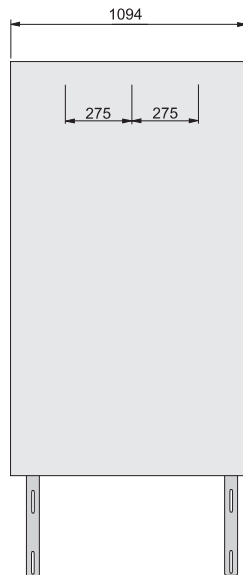

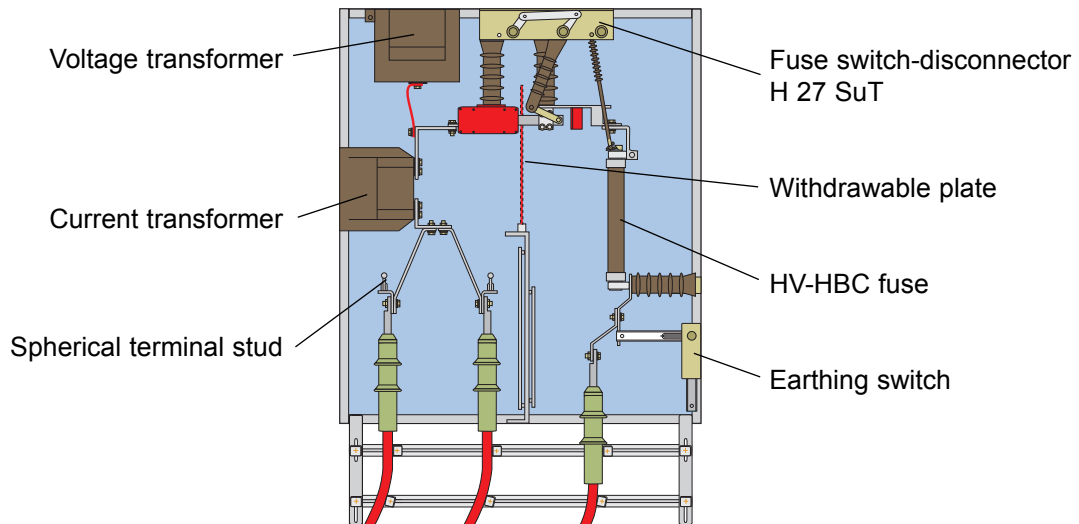

- Rated voltage
24 kV
- Rated (operating) current
400 A / 630 A
- Rated isolation level
125 kV

*Fig. 5:
24 kV Compact switchgear in
front and side view*









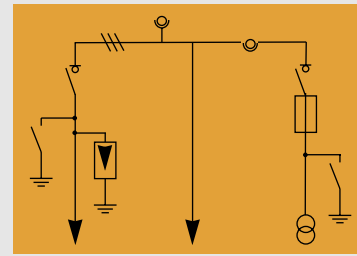
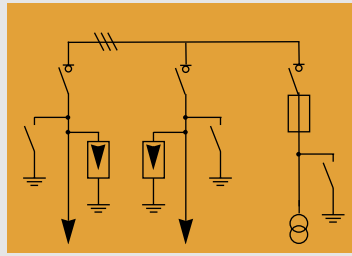

*Fig. 6:
24 kV Compact switchgear - open*

DRIESCHER - Compact Switchgears 24 kV

 optional
 not possible



Type D 24 - 171114

Switch-disconnector	H 27 EK	H 27 SuT	H 27 EK	H 27 SuT
Earthing switch				
Current transformer	-	-		
Voltage transformer	-	-		

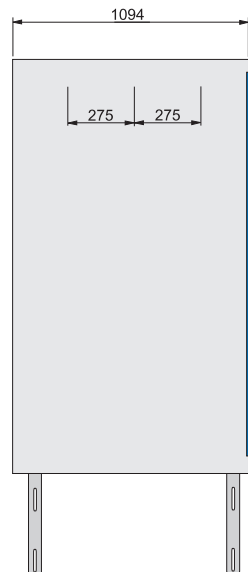
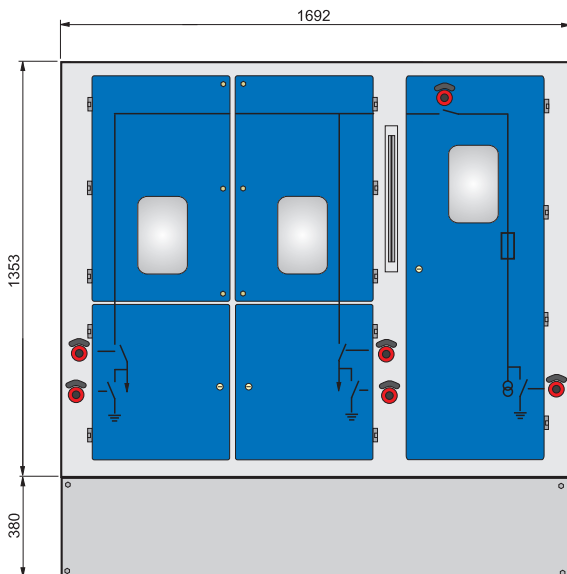

- Rated voltage
24 kV
- Rated (operating) current
400 A / 630 A
- Rated isolation level
125 kV

Fig. 7:
24 kV Compact switchgear in front and side view

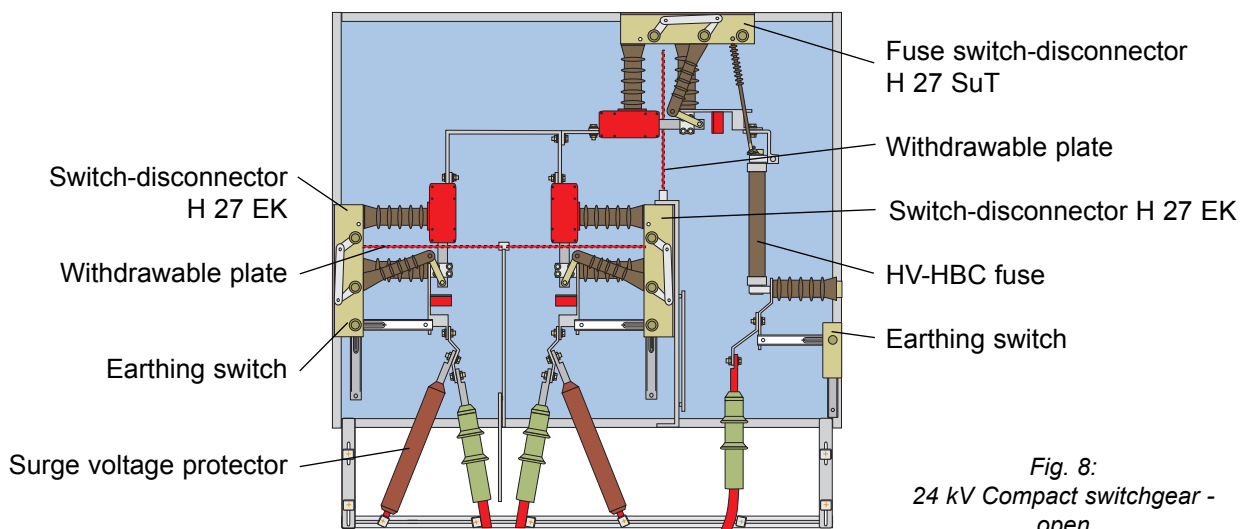

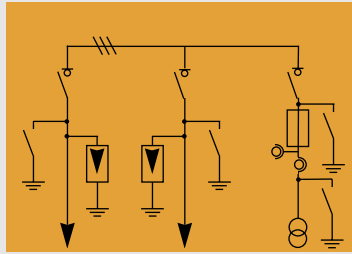

Fig. 8:
24 kV Compact switchgear - open







DRIESCHER - Compact Switchgears 24 kV

-  optional
-  not possible



- Rated voltage
24 kV
- Rated (operating) current
400 A / 630 A
- Rated isolation level
125 kV

Type D 24 - 211114

Switch-disconnector	H 27 EK	H 27 SEA
Earthing switch		
Current transformer		
Voltage transformer		

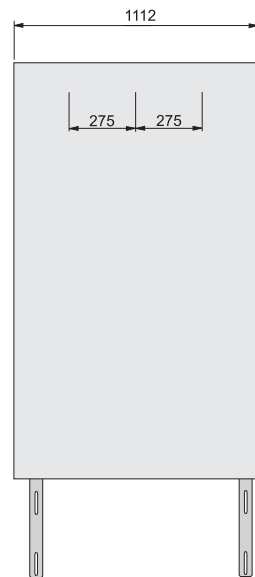
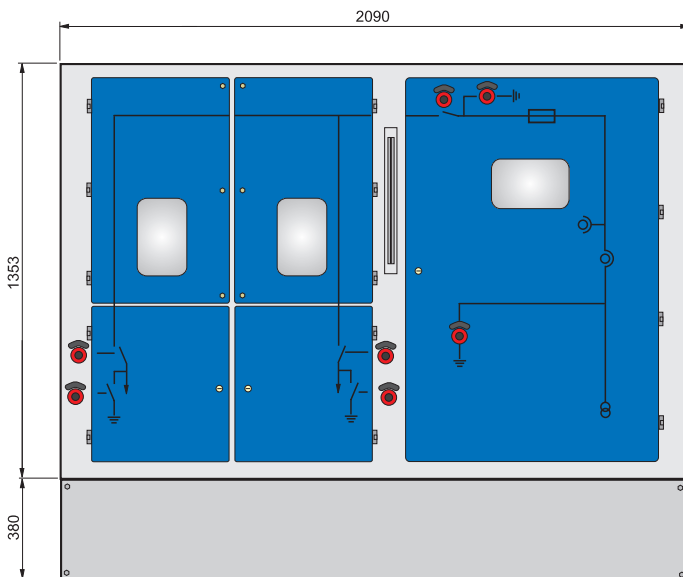
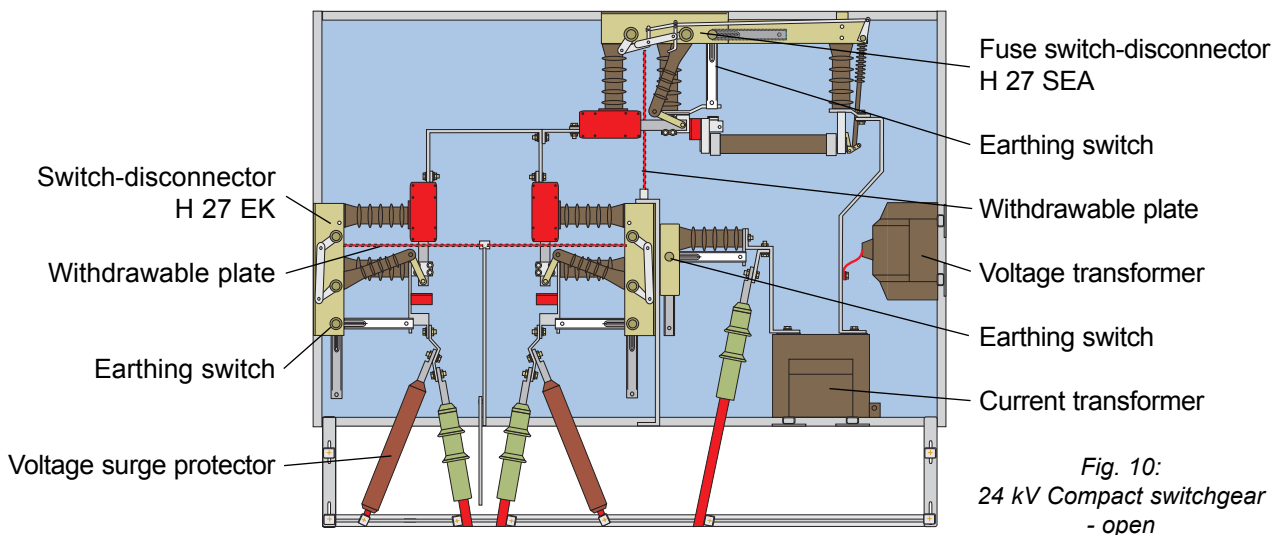

Fig. 9:
24 kV Compact switchgear in front and side view



- Fuse switch-disconnector H 27 SEA
- Earthing switch
- Withdrawable plate
- Voltage transformer
- Earthing switch
- Current transformer

Fig. 10:
24 kV Compact switchgear - open

Available Auxiliary Equipment

Designation

- Cable panel with surge voltage protector
- Installation of test sockets for capacitive voltage tapping
- Attachment of a fuse box
- Cable panel with switch-disconnector 400 A and 630 A
- Transformer panel with switch-disconnector 400 A and 630 A
- Additional locking features with profile cylinder and lockable operating mechanisms
- Base
- Installation of various short-circuit display systems
- Panel illumination
- Delivery is possible with voltage display and transformer system DEHNcap/AWS for measuring phase-to-earth and phase-to-phase voltages for control and protection

Required Plant Accessories

Designation

- 1 manual operating lever
- 1 door key with double-bit DIN 43668, size 5
- 1 FRP withdrawable plate, red, Type 1165, VDE 0681, Part 8
- for additional station accessories please refer to List 773

Weights

Type	Weight with maximum equipment approx.kg	Drawing-no.
D 12 - 127014	390	KS2 - 094311
D 12 - 147014	480	KS2 - 094311
D 24 - 121114	630	KS2 - 094311
D 24 - 171114	590	KS2 - 094311
D 24 - 211114	960	KS3 - 097157

For assembly, commissioning and maintenance always proceed as specified in the appropriate instructions.

Our range of products includes:

Medium-voltage systems

- Single-bus and duplicate-bus switchgear
- Non-withdrawable, withdrawable, and truck-type units
- Compact switchgear assemblies
- Custom-made models
- Industrial systems

Medium-voltage switchgear

- Indoor switches, disconnectors, and earthing switches (single and triple pole)
- Indoor circuit breakers (low oil content and vacuum)
- Outdoor switches (low oil content and vacuum)
- High-voltage high-breaking-capacity fuses

Low-voltage systems

- Open-framework design
- Enclosed break devices (up to 6,000 A)
- Cable and fixed-station distribution cabinets

Low-voltage switchgear

- Switch disconnectors
- Switch and fuse blocks
- Low-voltage high-breaking-capacity fuses

Driving gear

- Hand-operated and motor-operated mechanisms
- Indoor and outdoor driving gear

Accessories

- For medium and low voltages
- For station equipment
- Insulators (0.5 kV - 38.5 kV)
- Plastic and glass-reinforced plastic screening

Dimensions, weights, diagrams and descriptions in the list are non-binding. Subject to change without notice.

switching • electricity • safely

ELEKTROTECHNISCHE WERKE FRITZ DRIESCHER & SÖHNE GMBH

D-85366 MOOSBURG • TEL. +49 87 61 6 81-0 • FAX +49 87 61 68 11 37
<http://www.driescher.com> email: Driescher@aol.com

