

## DRIESCHER - Air-Insulated Medium-Voltage Switchgears

- Type W 36 - 901221 and
- Type W 36 - 901226
- Rated voltage 36 kV
- Rated current 630 A / 1250 A



# W 36

ELEKTROTECHNISCHE WERKE  
FRITZ DRIESCHER & SÖHNE GMBH

D-85366 MOOSBURG • TEL. +49 87 61 6 81-0 • FAX +49 87 61 68 12 30  
<http://www.driescher.com> email: [Driescher@aol.com](mailto:Driescher@aol.com)



## DRIESCHER - 36 kV Switch Panels

in compliance with DIN VDE 0670, Part 6 and IEC 60298

• 2	<b>General, Operating Conditions, Technical Standards</b>
• 3	<b>Technical Data, Description of Switch Panels, Withdrawable Plates</b>
• 4	<b>Panel Variants W 36 - 901221</b>
• 5	<b>Panel Types</b>
• 6	<b>Panel Variants W 36 - 901226</b>
• 7	<b>Panel Types</b>
• 8	<b>Auxiliary Equipment, Weights</b>

### General

The compartment-type air-insulated medium-voltage switchgears of Type W 36 are used by our customers whenever a high security of supply has to be guaranteed and also for ensuring operator safety and operating convenience.

Special phase barrier plates of fibrous glass reinforced plastic enable a switch panel width of just 900 mm at a rated voltage of 36 kV.

Switch panels of Type W 36 are available in two standard designs: W 36 -901221 and W 36 -901226.

The main dimensions of the panels are W x D x H: 900 x 1200 x 2100 or 2600 mm.

They can be delivered as individual panels where their equipment, panel sequence etc. can be determined by the customer.

The switchgears are type tested in compliance with DIN VDE 0670, Part 6, including the Pehla guideline no. 4.

### Operating Conditions

The switch panels of type W 36 are installed in closed electrical operating areas which are only to be entered by skilled personnel and appropriately instructed persons.

The installation can be implemented up to an altitude of 1000 m above sea level.

For installations above an altitude of 1000 m the rated insulating level of the switchgear must be corrected accordingly.

The switch panels are designed for use under normal operating conditions in compliance with DIN VDE 0670, Part 1000 (IEC 60694).

### Technical Standards

The design of the air-insulated switch panels corresponds to the specifications of the DIN VDE 0670, Part 6 (IEC 60298). The resistance to accidental arcs of the switch panels has been determined at 16 kA; 1 s by an independent testing institute.

The installed switchgear electrical equipment are designed in compliance with DIN VDE 0670, Part 1000 (IEC 60694).

The degree of protection of the switch panels corresponds to IP 3x..

For technical data on the installed switchgear equipment please refer to our brochures:

- for switch-disconnector H 29 see 729
- for earthing and disconnecting see 731
- for circuit breakers see 741 and 745

## Technical Data

Rated voltage	$U_r$ 36 kV	Rated short-time current	$I_k$ 16/(20) kA
Rated lightning impulse withstand voltage	$U_p$ 170 kV	Rated short-circuit duration	$t_k$ 3 s
Rated short-time withstand voltage	$U_d$ 70 kV	Permissible short-circuit duration with internal faults	1 s
Rated operating current	$I_r$ 630/1250 A	Rated frequency	$f_r$ 50 Hz

Technical data for the installed switchgear equipment	Rated (operating) current $I_r$	Rated short-time current $I_k$	Rated peak current $I_p$
Switch-disconnector H 29	630 A	20 kA	50 kA
Circuit breaker	630 A and 1250 A	20 kA	50 kA

## Switch Panels

### Design of switch panels

The switch panels of Type W 36 are of compartment-type design using fibrous glass reinforced plastic partition plates with lead-in openings. Connecting cables are introduced from below into the switch panels where they are attached to the provided fastening straps.

All built-in switchgear equipment can be manually operated with closed panel door.

### The switch panel housing

The framework of the switch panels is of a welded angular steel design.

The switch panels are fitted with a single-wing door of solid steel plate with door hinge optionally on the right or on the left. A window of compound glass is inserted in the door.

The cover in front of the bus bar area is either screwed on (Type W 36 - 901221) or designed as a door for the relay box behind (Type W 36 - 901226).

This relay box has the dimensions W x D x H: 900 x 350 x 822 mm and can be fitted with one or several protection relays, as required by the customer.

The corrosion protection of the framework, doors and covers as well as the end covers on the side of the switchgear is provided by structural paint (color RAL - in accordance with customer's request).

The partition of the busbar area bordering the next panel is in the form of fibrous glass reinforced plastic plates with lead-in openings.

Each switch panel has a bolted-on rear wall of galvanized sheet metal.

Pressure relief is in upward direction. It is possible to insert an insulating barrier plate (in compliance with DIN VDE 0681, Part 8) with the panel door closed.

### Equipment

The switch panels of Type W 36 - 901221 can be designed as cable or transformer feeder panels or also as circuit-breaker panels.

For this purpose they are fitted with switch-disconnectors or fuse-switch-disconnectors (Type H 29) to which a short-circuit-proof earthing switch with quick-make operation can optionally be attached.

Switch panels of Type W 36 - 901226 can be designed as cable or transformer feeder panels as well as circuit-breaker panels. These are fitted with a bus disconnector, a vacuum circuit-breaker as well as a set of current transformers.

The equipment can optionally be supplemented by an earthing switch and a set of voltage transformers. Spherical fixed points are available as an alternative for earthing and short-circuiting.

Switch-disconnectors and earthing switches are mechanically interlocked, if so requested by the customer.

It is possible to install corresponding surge voltage protectors in the panel, if required.

A special measuring panel equipped with current and voltage transformers completes the program.

The interlocking conditions are in compliance with DIN VDE 0670, Part 6.

## Withdrawable Plates

This insulating barrier plate is to prevent an impermissible approach or accidental contact of live parts. It is to be inserted with closed door if work is to be

carried out on the panel and the unit cannot be completely switched dead. The plate can be removed again by pulling at the grip hole.

## Switch Panels Type W 36 - 901221

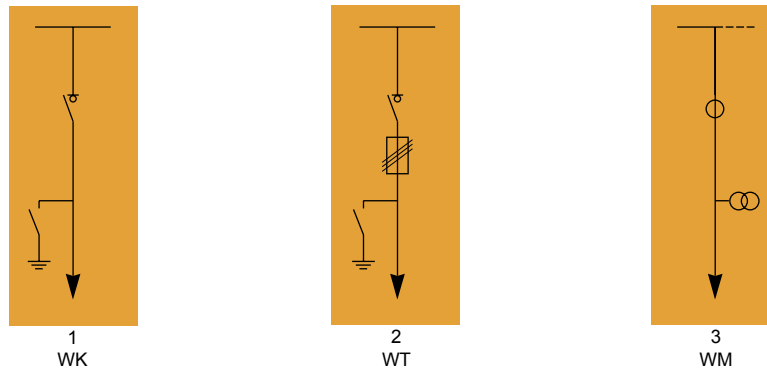
**DRIESCHER - Air-Insulated Medium-Voltage Standard Switch Panels 36 kV  
900 mm width, 1200 mm depth, 2100 mm height**

No.	Type	Disconnecter	Primary switchgear equipment	Earth	Current transformer	Voltage transformer	Designation
1	WK	36-901221-29	-	H 29 EA	◦	-	Cable panel
2	WT	36-901221-29	-	H 29 SEA	◦	-	Transformer feeder panel
3	WM	36-901221	-	-	◦	◦	Measuring panel

◦ = optional    - = not possible

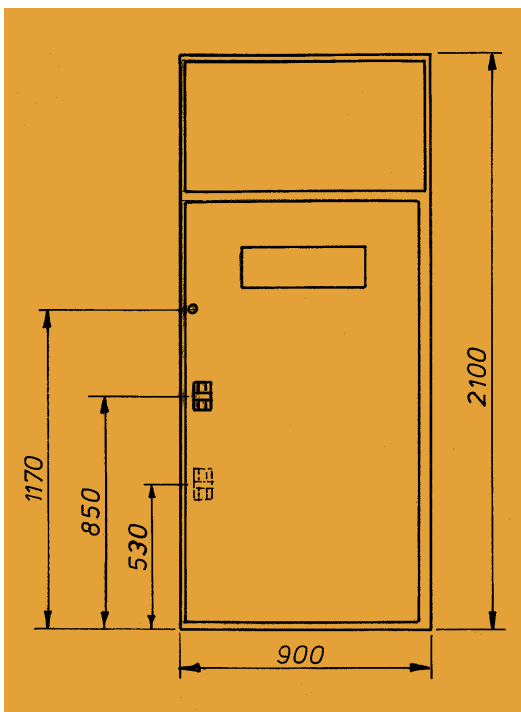

Fig. 1: 36 kV Switch panel

**36 kV Switch Panel as shown in Drawing HA 2-70785**

- Version as cable, transformer feeder or measuring panel
- Rated (operating) current 630 A
- Rated insulation level 170 kV
- Resistance to accidental arcs 16 kA; 1 s

Switch Panels Type W 36 - 901221

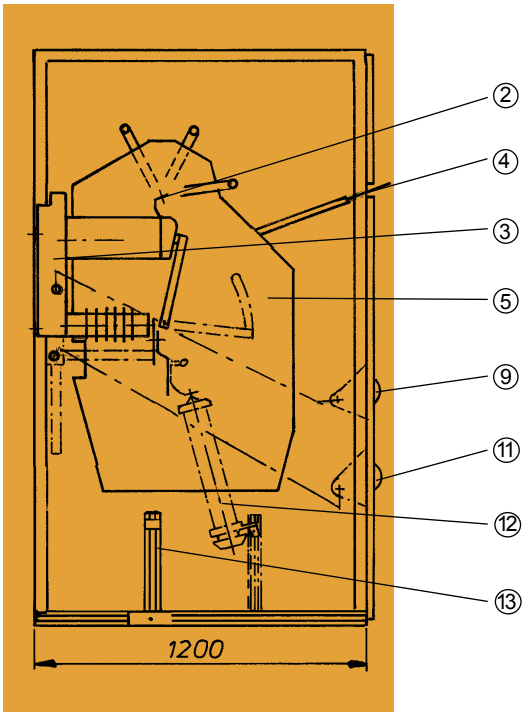

Fig. 2: 36 kV Cable panel with switch-disconnector H 29 EA

- ① Relay box
- ② Busbar terminal
- ③ Switch-disconnector H 29
- ④ Withdrawable plate
- ⑤ FRP Phase barrier plate
- ⑥ Current transformer
- ⑦ Voltage transformer
- ⑧ Vacuum circuit-breaker
- ⑨ Position and operation indicator switch-disconnector H 29
- ⑩ HV-HBC fuse
- ⑪ Position and operating indicator of earthing switch
- ⑫ Surge voltage protector
- ⑬ Adjustable cable fastening strap
- ⑭ Earthing switch

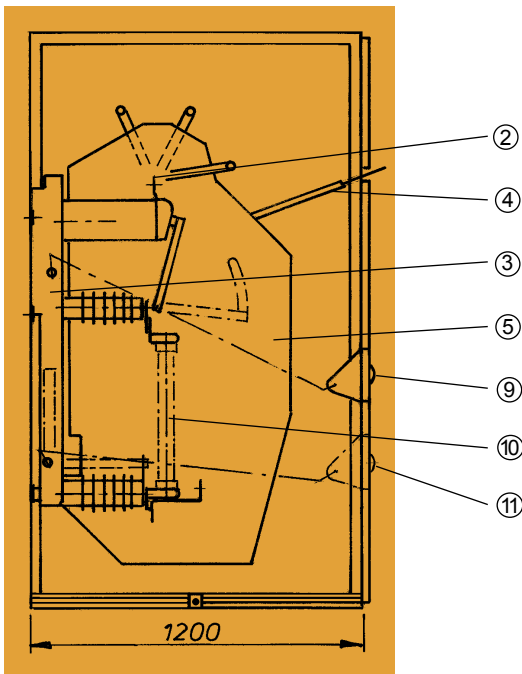

Fig. 3: 36 kV Transformer feeder panel with fuse-switch-disconnector H 29 SEA

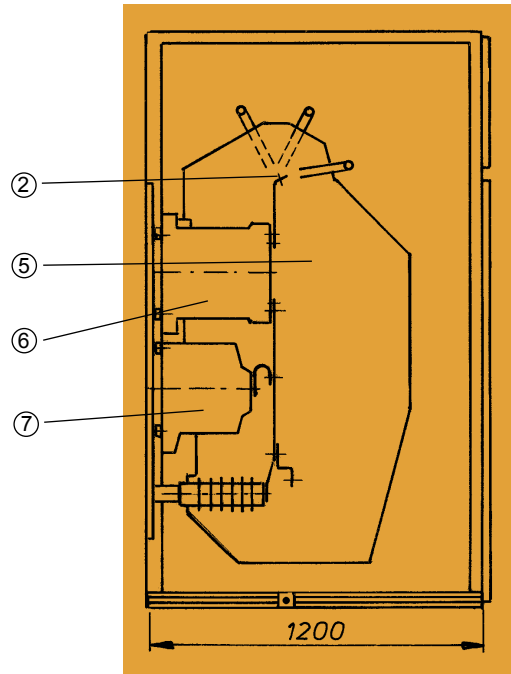
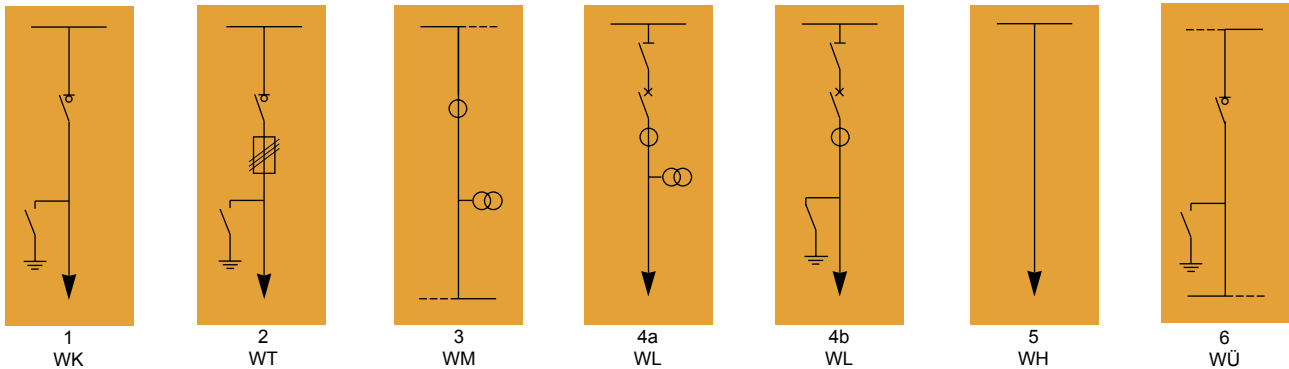

Fig. 4: 36 kV Measuring panel

## Switch Panels Type W 36 - 901226

**DRIESCHER - Air-Insulated Medium-Voltage Standard Switch Panels 36 kV**  
**900 mm width, 1200 mm depth, 2600 mm height**

No.	Type	Disconnector	Primary switchgear equipment	Earth	Current transformer	Voltage transformer	Designation
1	WK	36-901226-29	-	H 29 EA	°	-	Cable panel
2	WT	36-901226-29	-	H 29 SEA	°	-	Transformer feeder panel
3	WM	36-901226	-	-	°	°	Measuring panel
4a	WL	36-901226-V616	-	V616 F / V 616 KUF	°	°	Circuit-breaker panel
4b	WL	36-901226-V616	-	V616 F / V 616 KUF	°	°	Circuit-breaker panel
5	WH	36-901226	-	-	°	-	Riser panel
6	WÜ	36-901226-29	-	H 29 EA	°	-	Bus sectionalizer panel

° = optional - = not possible

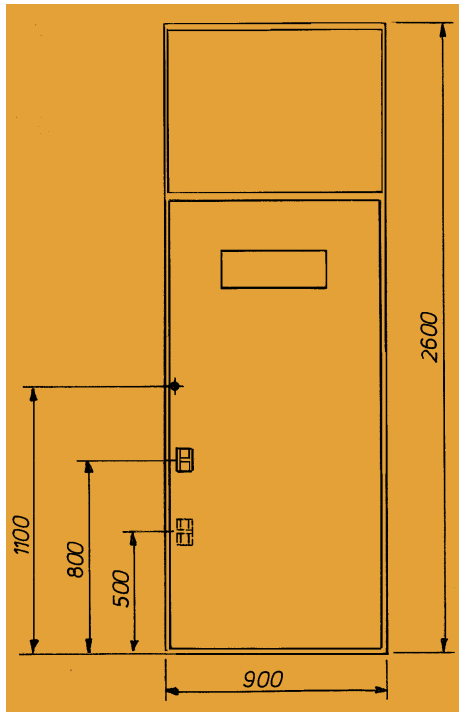

Fig. 5: 36 kV Switch panel with Switch-disconnector H 29

**36 kV Switch-Disconnector Panels**

- Rated (operating) current 630 A
- Rated insulation level 170 kV
- Resistance to accidental arcs 16 kA; 1 s.

**36 kV Circuit-Breaker Panels**

- Rated (operating) current 630 A / 1250 A
- Rated insulation level 170 kV
- Resistance to accidental arcs 16 kA (20 kA); 1 s.

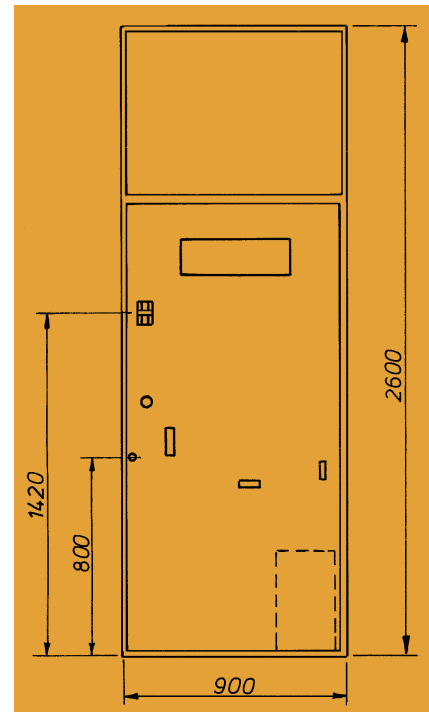

Fig. 6: 36 kV Switch panel with circuit breaker

Switch Panels Type W 36 - 901226

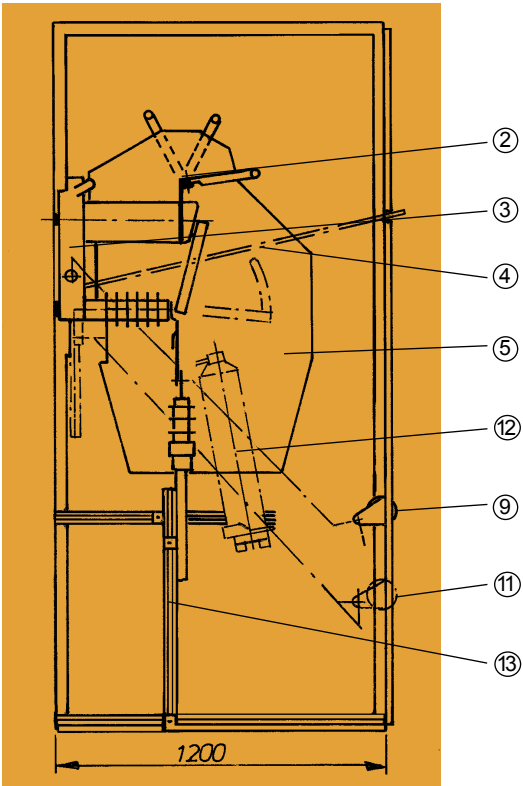

Fig. 7: 36 kV Cable panel with switch-disconnector H 29 EA

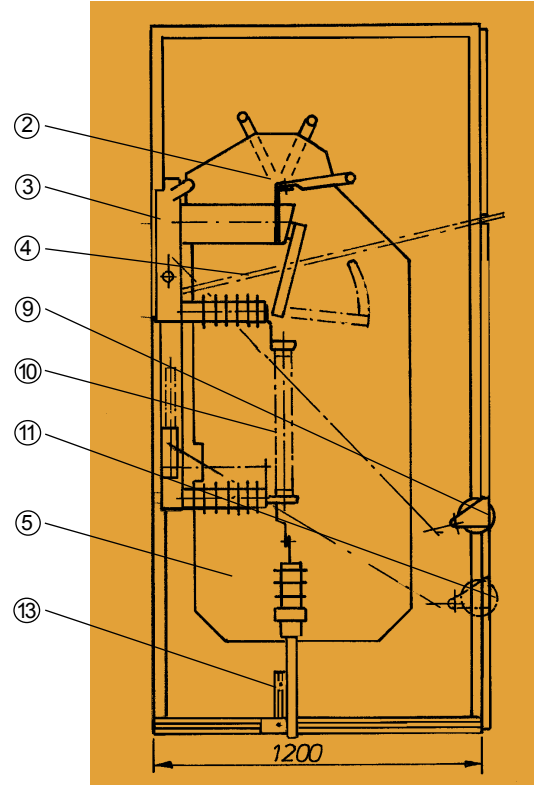

Fig. 8: 36 kV Transformer feeder panel with fuse-switch-disconnector H 29 SEA

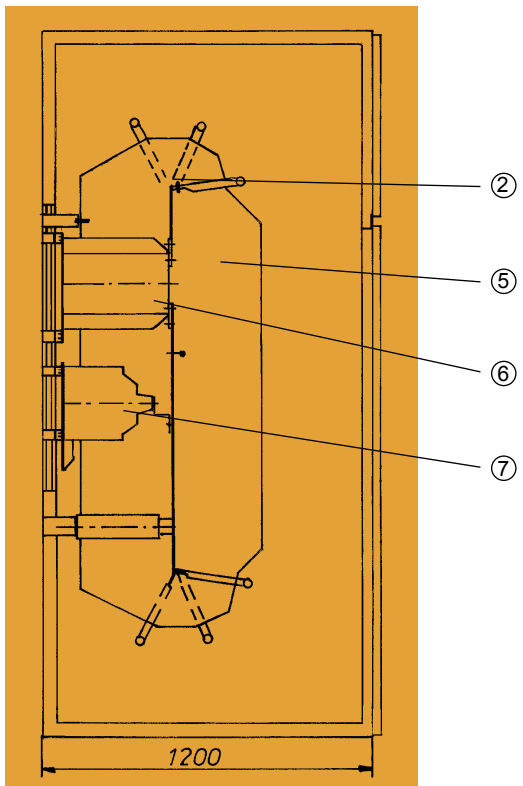

Fig. 9: 36 kV Measuring panel

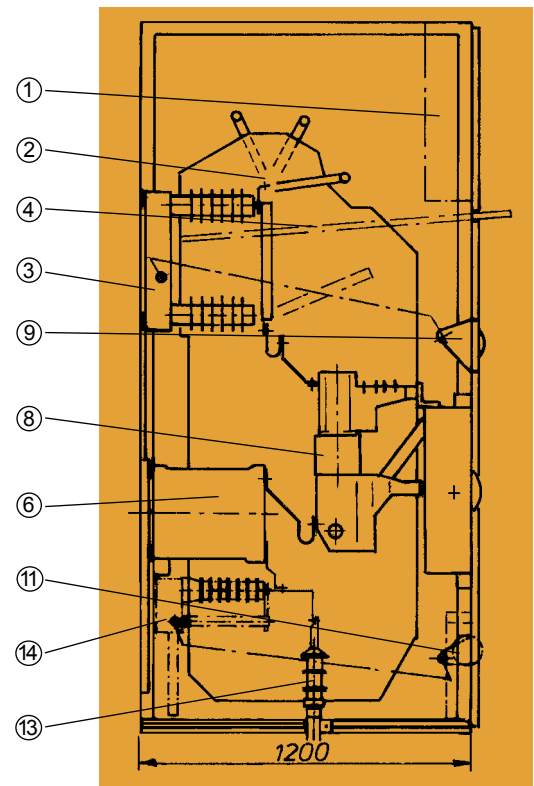

Fig. 10: 36 kV Switch panel with circuit-breaker V 620 KUF

## Switch Panels Type W 36 - 901226

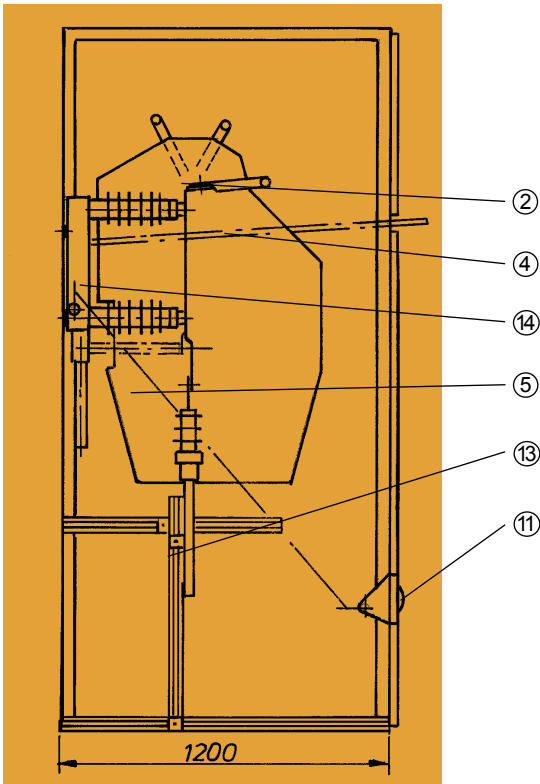

Fig. 11: 36 kV Cable riser panel

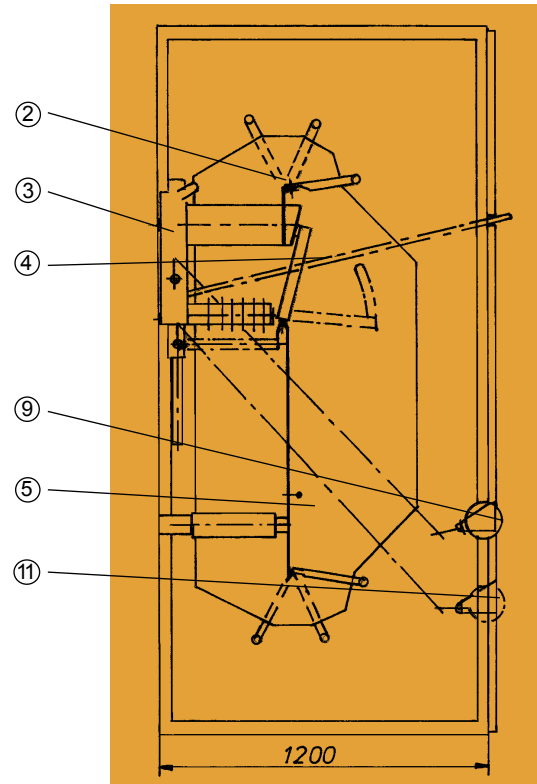

Fig. 12: 36 kV Bus sectionalizer panel with switch-disconnector H 29 EA

## Auxiliary Equipment

- Insulating protective plate in compliance with DIN VDE 0681 Part 8
- Capacitive voltage testing system in compliance with (E) DIN VDE 0682 Part 415
- Short-circuit indicator
- Floor coverings
- Panel lighting

## Weights

Type	Designation	Weight approx.kg	Drawing-no.
WK 36-901221 / 26-29	Cable panel	300 / 320	HA2-70785 / 70789
WT 36-901221 / 26-29	Transformer feeder panel	320 / 340	HA2-70785 / 70789
WM 36-901221 / 26	Measuring panel	380 / 400	HA2-70785 / 70789
WL 36-901226-V616	Circuit-breaker panel	750	HA2-70789
WH 36-901226	Riser panel	230	HA2-70789
WÜ 36-901226-29	Bus sectionalizer panel	350	HA2-70789

Dimensions, weights , diagrams and descriptions in the list are non-binding. Subject to change without notice.

switching • electricity • safely

ELEKTROTECHNISCHE WERKE  
FRITZ DRIESCHER & SÖHNE GMBH

D-85366 MOOSBURG • TEL. +49 87 61 6 81-0 • FAX +49 87 61 68 12 30  
http://www.driescher.com email: Driescher@aol.com

